

AC

## CONDIZIONATORI DA TETTO

TOP MOUNTING AIR CONDITIONERS

KLIMAGERÄT FÜR DACHMONTAGE

ACONDICIONADORES DE AIRE PARA TECHO

### INDOOR

#### TOP II

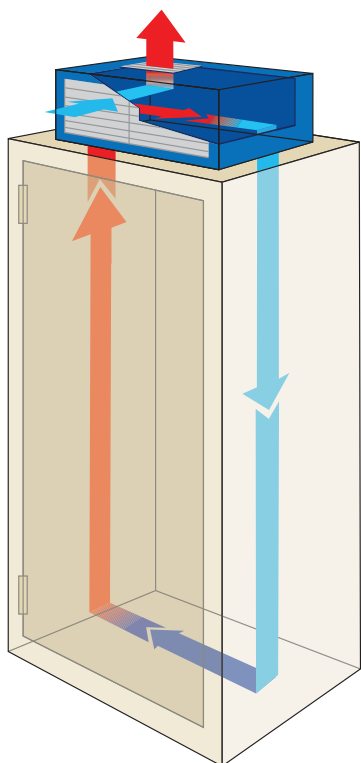

#### COMMON FEATURES

- Top mounting air conditioner
- Self Cleaning Condenser
- Hydrophilic evaporator
- 5 sizes
- Cooling Capacity 330-5200 W
- Condensate dissipating device from ETE14
- Quick connections (except ETE03)
- Digital Thermostat ECB (except ETE03)



#### CARATTERISTICHE GENERALI

- Condizionatore da tetto
- Condensatore autopulente
- Evaporatore idrofilico anticondensa
- 5 taglie
- Capacità frigorifere: 330-5200 W
- Dissipatore di condensa presente da modello ETE14
- Connessioni rapide (eccetto ETE03)
- Termostato digitale ECB (eccetto ETE03)



#### ALLGEMEINE MERKMALE

- Klimagerät für Dachmontage
- Selbstreinigender Kondensator
- Hydrophil beschichteter Verdampfer
- 5 Abmessungen
- Kälteleistung 330-5200 W
- Kondensatverdampfung ab ETE14
- Schnellverbindungen (außer ETE03)
- Digital Thermostat (außer ETE03)



#### CARACTERÍSTICAS COMUNES

- Acondicionador para techo
- Condensador auto-limpiante
- Evaporador hidrofílico anti-condensación
- 5 tamaños
- Capacidad frigorífica: 330-5200 W
- Disipador de condensación presente desde el modelo ETE14
- Conexiones rápidas (excepto en ETE03)
- Termostato digital ECB (excepto en ETE03)



## TOP II ETE03

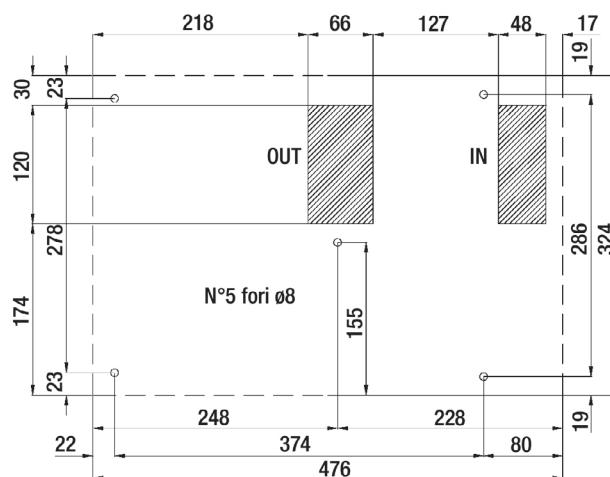
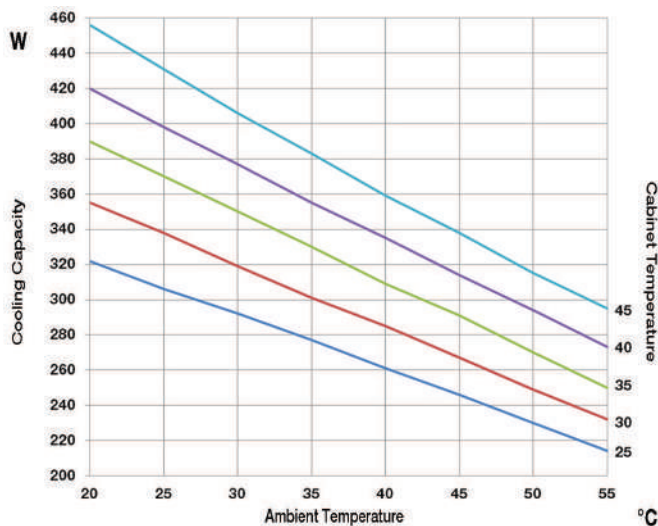
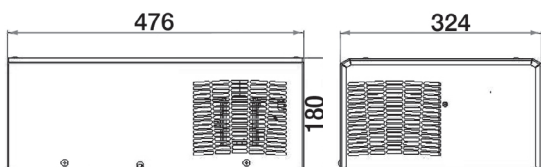

CODE - CODICE - MODEL - CODIGO	M.U.	ETE0300220	ETE0300203
Power supply - Alimentazione - Spannungsversorgung - Tensión	V - ph - Hz	230-1-50/60	115-1-60
Cooling capacity L35L35 - Potenza raffreddamento L35L35 Kälteleistung L35L35 - Potencia frigorífica L35L35 - DIN 3168	W	330	330
Cooling capacity L35L50 - Potenza raffreddamento L35L50 Kälteleistung L35L50 - Potencia frigorífica L35L50 - DIN 3168	W	270	270
Height / Widht / Depth - Altezza / Larghezza / Profondità Höhe / Breite / Tiefe - Altura / Ancho / Profundidad	mm	180x476x324	180x476x324
Max running current - corrente max, in marcia Max. Stromaufnahme - Corriente máxima, en marcha	A	1,4	2,8
Starting current - Corrente assorbita alla partenza Anlaufstrom - Corriente absorbida al arranque	A	5	10
Pre-Fuse T - Fusibile T - Absicherung T - Elemento previo de fusibile T	A	4	4
Power consumption L35L50 - Potenza assorbita L35L50 Leistungsaufnahme L35L50 - Potencia absorbida L35L50 - DIN3168	W	240	240
Side cabinet fan flow, free blowing - Portata aria ventil. lato armadio, bocca libera Luftmenge Schrankseite, freiblasend - Caudal aire ventil. Lado armario	m3/h	164	164
Regulation Temperature limits - Limiti di regolazione temperatura Temperatur Einstellbereich - limites de ajuste de temperatura	°C	25 - 45	25 - 45
Side ambient Temperature limits - Limiti di Temperatura lato ambiente Umgebungstemperatur - Limites Temperatura lado ambiente	°C	20 - 55	20 - 55
Side cabinet protection degree - Protezione lato armadio Schutzgrad Schrankseite - Protección lado armario	IP	54	54
Noise level - Rumorosità - Geräuschpegel - Nivel de ruido	dB(A)	60	60
Weight - Peso - Gewicht - Peso	kg	17	18

### OPTIONAL

Special Colour - Colore Speciale OCAHNS02  
 Stainless Steel Housing - Carpentaria Inox AISI304 OCAHI06



## TOP II ETE06

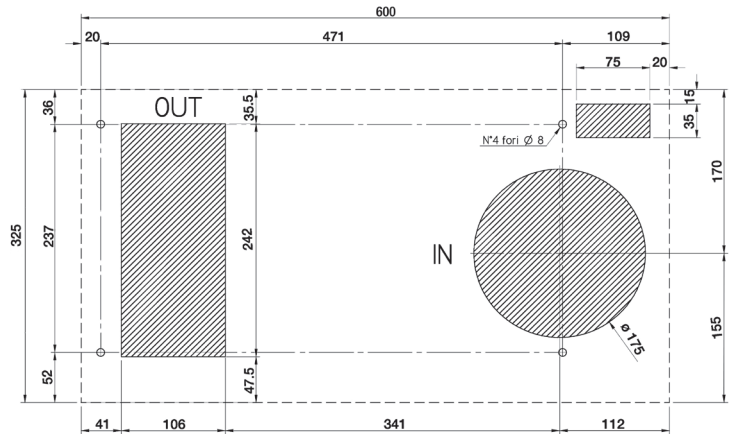
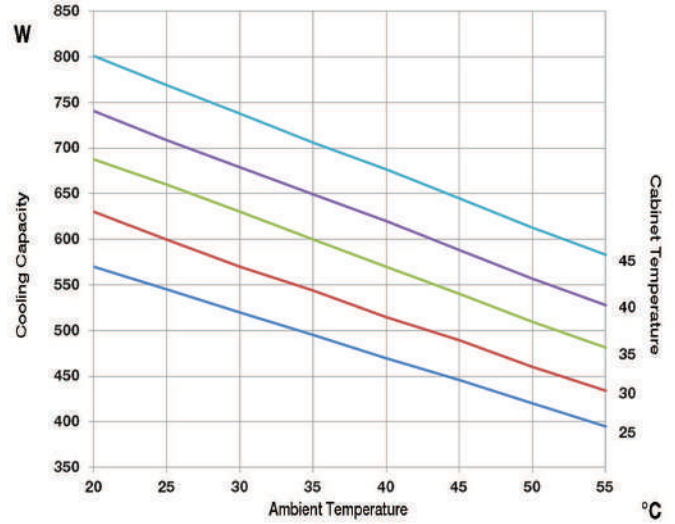
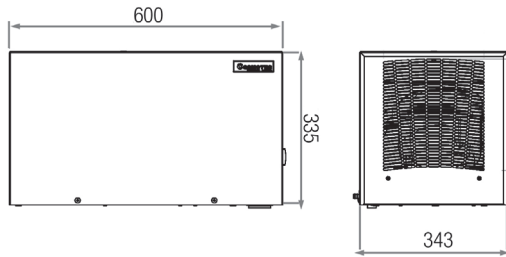

CODE - CODICE - MODEL - CODIGO	M.U.	ETE06012207000	ETE06U12207000	ETE06U12037000	ETE06012287000
Power supply - Alimentazione - Spannungsversorgung - Tensiòn	V - ph - Hz	230-1-50/60	230-1-50/60	115-1-60	400-2-50 460-2-60
Cooling capacity L35L35 - Potenza raffreddamento L35L35 Kälteleistung L35L35 - Potencia frigorífica L35L35 - DIN 3168	W	600	600	600	600
Cooling capacity L35L50 - Potenza raffreddamento L35L50 Kälteleistung L35L50 - Potencia frigorífica L35L50 - DIN 3168	W	510	510	510	510
Height / Widht / Depth - Altezza / Larghezza / Profondità Höhe / Breite / Tiefe - Altura / Ancho / Profundidad	mm	335x600x325	335x600x325	335x600x325	335x600x325
Max running current - corrente max, in marcia Max. Stromaufnahme - Corriente máxima, en marcha	A	2,2	3	4,5	1,2
Starting current - Corrente assorbita alla partenza Anlaufstrom - Corriente absorbida al arranque	A	16	16	29	7,7
Pre-Fuse T - Fusibile T - Absicherung T - Elemento previo de fusibile T	A	4	4	6	4
Power consumption L35L50 - Potenza assorbita L35L50 Leistungsaufnahme L35L50 - Potencia absorbida L35L50 - DIN3168	W	411	411	411	411
Side cabinet fan flow, free blowing - Portata aria ventil. lato armadio, bocca libera Luftmenge Schrankseite, freiblasend - Caudal aire ventil. Lado armario	m3/h	575	575	575	575
Regulation Temperature limits - Limiti di regolazione Temperatura Temperatur Einstellbereich - limites de ajuste de Temperatura	°C	25 - 45	25 - 45	25 - 45	25 - 45
Side ambient Temperature limits - Limiti di Temperatura lato ambiente Umgebungstemperatur - Limites Temperatura lado ambiente	°C	20 - 55	20 - 55	20 - 55	20 - 55
Side cabinet protection degree - Protezione lato armadio Schutzgrad Schrankseite - Protección lado armario	IP	54	54	54	54
Noise level - Rumorosità - Geräuschpegel - Nivel de ruido	dB(A)	63	63	63	63
Weight - Peso - Gewicht - Peso	kg	29,5	29,5	29,5	32

**OPTIONAL**

Special Colour - Colore Speciale OCAHNS03  
 Stainless Steel Housing - Carpenteria Inox AISI304 OCAHI06  
 Air Filter - Filtro Aria ACAFILTO6T





# TOP II ETE09

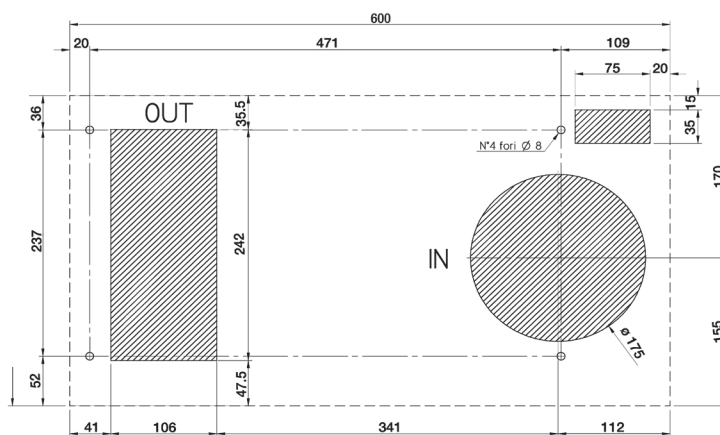
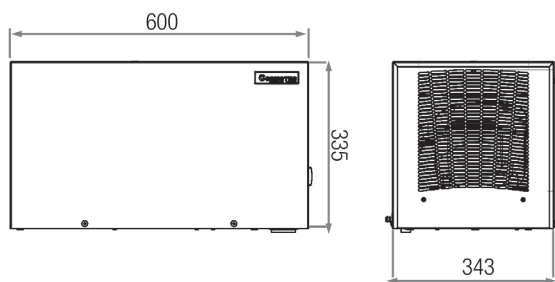
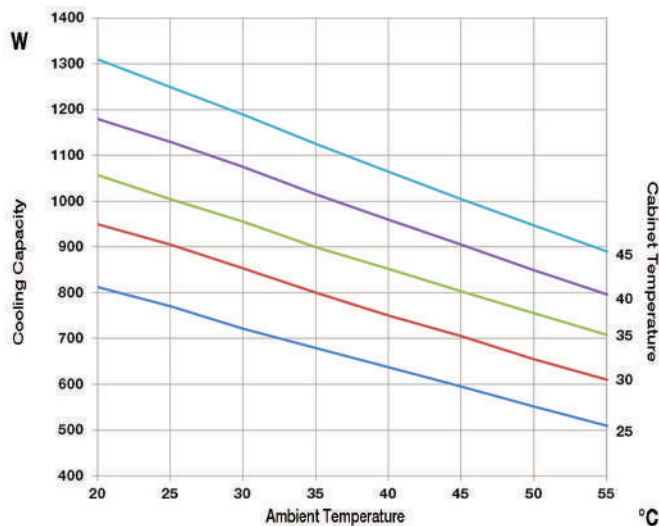

CODE - CODICE - MODEL - CODIGO	M.U.	ETE09012207000	ETE09U12207000	ETE09U12037000	ETE09012287000
Power supply - Alimentazione - Spannungsversorgung - Tensión	V - ph - Hz	230-1-50/60	230-1-50/60	115-1-60	400-2-50 460-2-60
Cooling capacity L35L35 - Potenza raffreddamento L35L35 - Kälteleistung L35L35 - Potencia frigorífica L35L35 - DIN 3168	W	900	900	900	900
Cooling capacity L35L50 - Potenza raffreddamento L35L50 - Kälteleistung L35L50 - Potencia frigorífica L35L50 - DIN 3168	W	760	760	760	760
Height / Widht / Depth - Altezza / Larghezza / Profondità - Höhe / Breite / Tiefe - Altura / Ancho / Profundidad	mm	335x600x325	335x600x325	335x600x325	335x600x325
Max running current - corrente max, in marcia - Max. Stromaufnahme - Corriente máxima, en marcha	A	3,2	4	8	1,8
Starting current - Corrente assorbita alla partenza - Anlaufstrom - Corriente absorbida al arranque	A	15	15	15	31
Pre-Fuse T - Fusibile T - Absicherung T - Elemento previo de fusible T	A	6	6	12	6
Power consumption L35L50 - Potenza assorbita L35L50 - Leistungsaufnahme L35L50 - Potencia absorbida L35L50 - DIN3168	W	630	630	630	630
Side cabinet fan flow, free blowing - Portata aria ventil. lato armadio, bocca libera - Luftmenge Schrankseite, freiblasend - Caudal aire ventil. Lado armario	m3/h	575	575	575	575
Regulation Temperature limits - Limiti di regolazione Temperatura - Temperatur Einstellbereich - limites de ajuste de Temperatura	°C	25 - 45	25 - 45	25 - 45	25 - 45
Side ambient Temperature limits - Limiti di Temperatura lato ambiente - Umgebungstemperatur - Limites Temperatura lado ambiente	°C	20 - 55	20 - 55	20 - 55	20 - 55
Side cabinet protection degree - Protezione lato armadio - Schutzgrad Schrankseite - Protección lado armario	IP	54	54	54	54
Noise level - Rumorosità - Geräuschpegel - Nivel de ruido	dB(A)	67	67	67	67
Weight - Peso - Gewicht - Peso	kg	31,5	31,5	31,5	33

#### OPTIONAL

Special Colour - Colore Speciale	OCAHNS03
Stainless Steel Housing - Carpentaria Inox AISI304	OCAHI06
Air Filter - Filtro Aria	ACAFILT06T





# TOP II ETE14

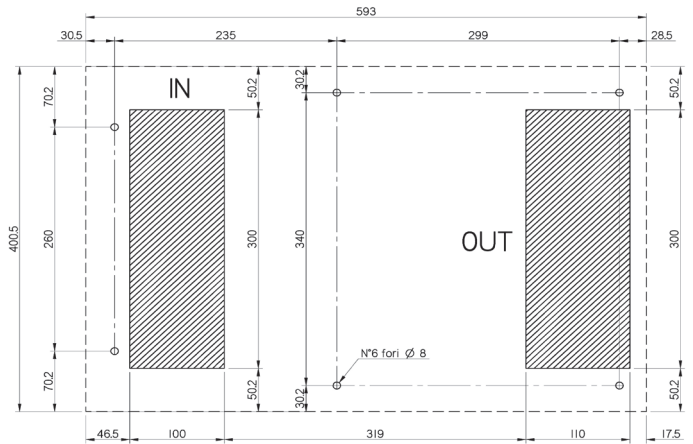
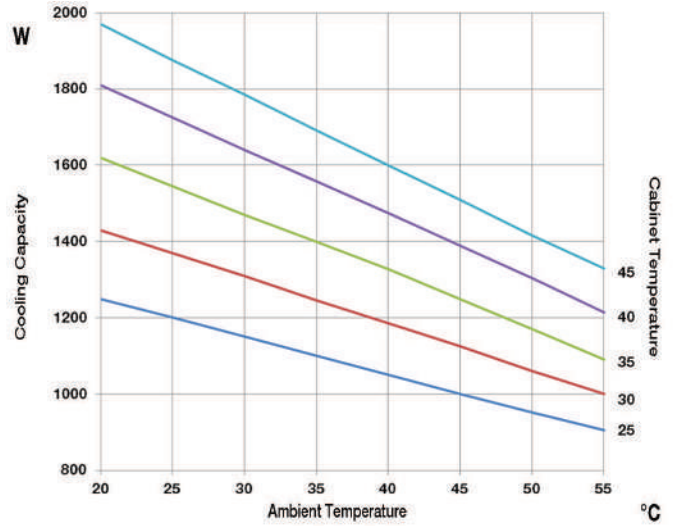
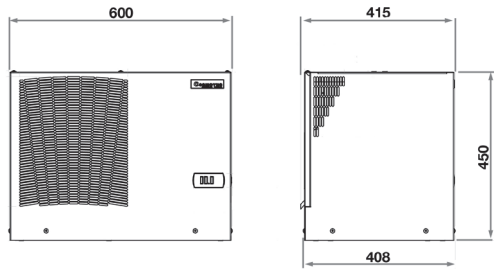

CODE - CODICE - MODEL - CODIGO	M.U.	ETE14002207000	ETE14U02207000	ETE14U02037000	ETE14002287000
Power supply - Alimentazione - Spannungsversorgung - Tensiòn	V - ph - Hz	230-1-50/60	230-1-50/60	115-1-60	400-2-50 460-2-60
Cooling capacity L35L35 - Potenza raffreddamento L35L35 Kälteleistung L35L35 - Potencia frigorífica L35L35 - DIN 3168	W	1400	1400	1400	1400
Cooling capacity L35L50 - Potenza raffreddamento L35L50 Kälteleistung L35L50 - Potencia frigorífica L35L50 - DIN 3168	W	1170	1170	1170	1170
Height / Widht / Depth - Altezza / Larghezza / Profondità Höhe / Breite / Tiefe - Altura / Ancho / Profundidad	mm	450x600x400	450x600x400	450x600x400	450x600x400
Max running current - corrente max, in marcia Max. Stromaufnahme - Corriente máxima, en marcha	A	5,2	5,5	10	2,8
Starting current - Corrente assorbita alla partenza Anlaufstrom - Corriente absorbida al arranque	A	17	17	34	31
Pre-Fuse T - Fusibile T - Absicherung T - Elemento previo de fusibile T	A	8	8	16	10
Power consumption L35L50 - Potenza assorbita L35L50 Leistungsaufnahme L35L50 - Potencia absorbida L35L50 - DIN3168	W	950	950	950	950
Side cabinet fan flow, free blowing - Portata aria ventil. lato armadio, bocca libera Luftmenge Schrankseite, freiblasend - Caudal aire ventil. Lado armario	m3/h	575	575	575	575
Regulation Temperature limits - Limiti di regolazione Temperatura Temperatur Einstellbereich - limites de ajuste de Temperatura	°C	25 - 45	25 - 45	25 - 45	25 - 45
Side ambient Temperature limits - Limiti di Temperatura lato ambiente Umgebungstemperatur - Limites Temperatura lado ambiente	°C	20 - 55	20 - 55	20 - 55	20 - 55
Side cabinet protection degree - Protezione lato armadio Schutzgrad Schrankseite - Protección lado armario	IP	54	54	54	54
Noise level - Rumorosità - Geräuschpegel - Nivel de ruido	dB(A)	58	58	58	58
Weight - Peso - Gewicht - Peso	kg	48	48	48	53

**OPTIONAL**

- Special Colour - Colore Speciale OCAHNS03
- Stainless Steel Housing - Carpenteria Inox AISI304 OCAHI06
- Air Filter - Filtro Aria ACAFIL14T





# TOP II ETE20

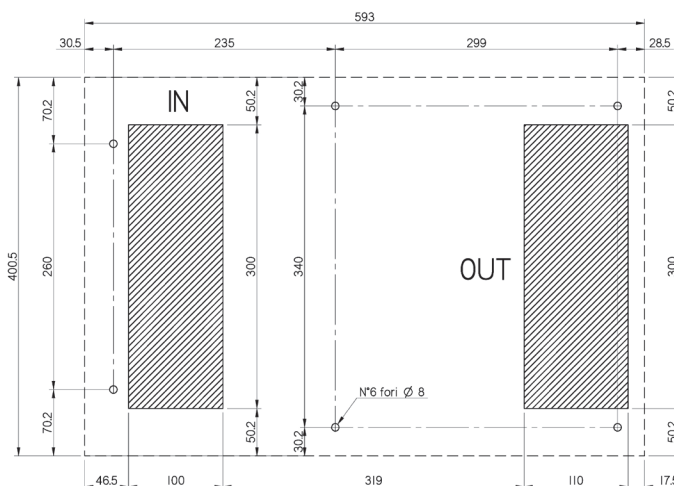
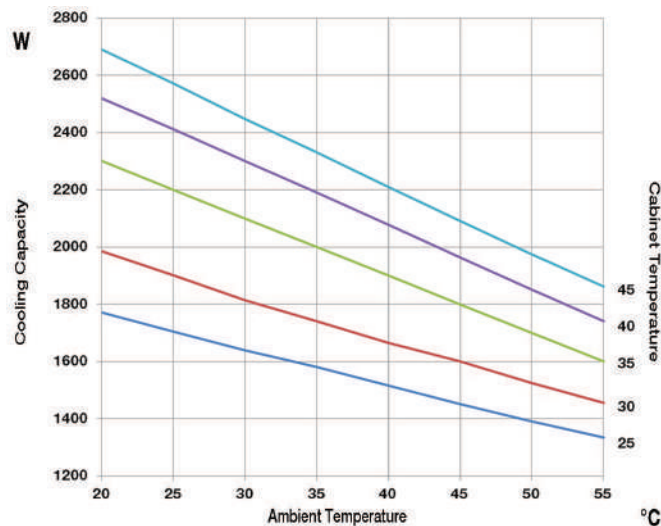
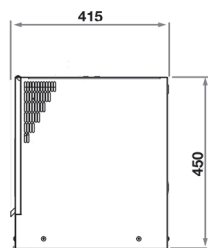
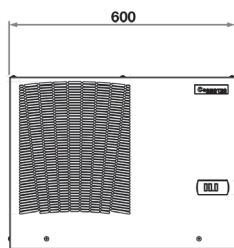

CODE - CODICE - MODEL - CODIGO	M.U.	ETE20002207000	ETE20U02207000	ETE20002287000
Power supply - Alimentazione - Spannungsversorgung - Tensión	V - ph - Hz	230-1-50/60	230-1-50/60	400-2-50 460-2-60
Cooling capacity L35L35 - Potenza raffreddamento L35L35 Kälteleistung L35L35 - Potencia frigorífica L35L35 - DIN 3168	W	2000	2000	2000
Cooling capacity L35L50 - Potenza raffreddamento L35L50 Kälteleistung L35L50 - Potencia frigorífica L35L50 - DIN 3168	W	1700	1700	1700
Height / Widht / Depth - Altezza / Larghezza / Profondità Höhe / Breite / Tiefe - Altura / Ancho / Profundidad	mm	450x600x400	450x600x400	450x600x400
Max running current - corrente max. in marcia Max. Stromaufnahme - Corriente máxima, en marcha	A	5,7	7	3,3
Starting current - Corrente assorbita alla partenza Anlaufstrom - Corriente absorbida al arranque	A	22	22	31
Pre-Fuse T - Fusibile T - Absicherung T - Elemento previo de fusibile T	A	8	10	10
Power consumption L35L50 - Potenza assorbita L35L50 Leistungsaufnahme L35L50 - Potencia absorbida L35L50 - DIN3168	W	1200	1200	1200
Side cabinet fan flow, free blowing - Portata aria ventil. lato armadio, bocca libera Luftmenge Schrankseite, freiblasend - Caudal aire ventil. Lado armario	m3/h	860	860	860
Regulation Temperature limits - Limiti di regolazione Temperatura Temperatur Einstellbereich - limites de ajuste de Temperatura	°C	25 - 45	25 - 45	25 - 45
Side ambient Temperature limits - Limiti di Temperatura lato ambiente Umgebungstemperatur - Limites Temperatura lado ambiente	°C	20 - 55	20 - 55	20 - 55
Side cabinet protection degree - Protezione lato armadio Schutzgrad Schrankseite - Protección lado armario	IP	54	54	54
Noise level - Rumorosità - Geräuschpegel - Nivel de ruido	dB(A)	62	62	62
Weight - Peso - Gewicht - Peso	kg	51,5	51,5	58,5

### OPTIONAL

Special Colour - Colore Speciale	OCAHNS03
Stainless Steel Housing - Carpentaria Inox AISI304	OCAHI06
Air Filter - Filtro Aria	ACAFILT14T





## TOP II ETE28

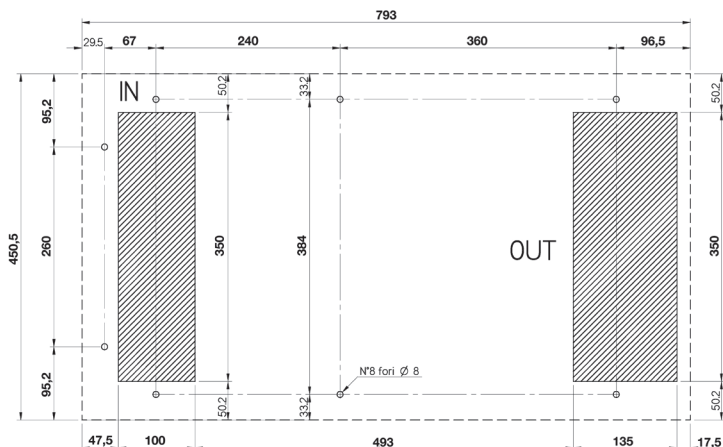
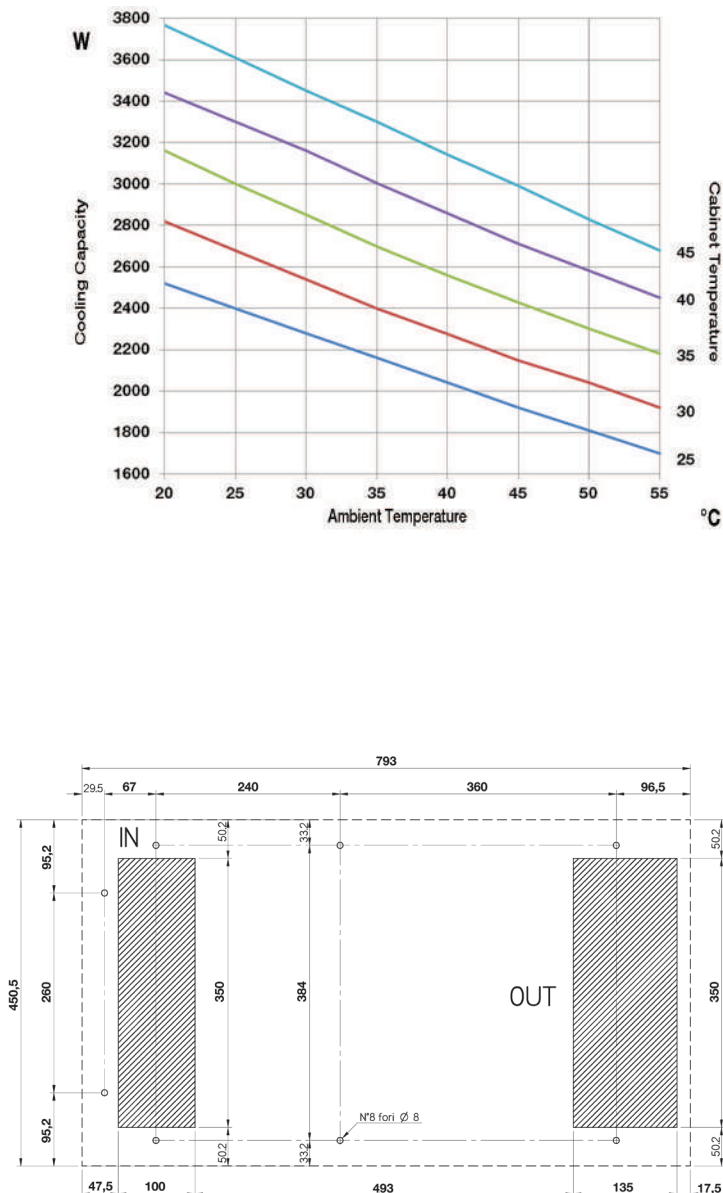
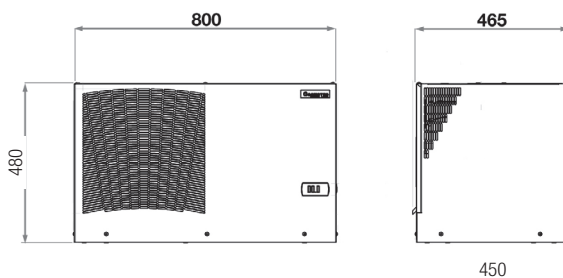

CODE - CODICE - MODEL - CODIGO	M.U.	ETE28002207000	ETE28U02207000	ETE28002617000
Power supply - Alimentazione - Spannungsversorgung - Tensiòn	V - ph - Hz	230-1-50/60	230-1-50/60	400-3-50 460-3-60
Cooling capacity L35L35 - Potenza raffreddamento L35L35 - Kälteleistung L35L35 - Potencia frigorífica L35L35 - DIN 3168	W	2700	2700	2700
Cooling capacity L35L50 - Potenza raffreddamento L35L50 - Kälteleistung L35L50 - Potencia frigorífica L35L50 - DIN 3168	W	2300	2300	2300
Height / Widht / Depth - Altezza / Larghezza / Profondità - Höhe / Breite / Tiefe - Altura / Ancho / Profundidad	mm	480x800x450	480x800x450	480x800x450
Max running current - corrente max, in marcia - Max. Stromaufnahme - Corriente máxima, en marcha	A	7	9,5	2,3
Starting current - Corrente assorbita alla partenza - Anlaufstrom - Corriente absorbida al arranque	A	38	38	16
Pre-Fuse T - Fusibile T - Absicherung T - Elemento previo de fusibile T	A	12	12	6
Power consumption L35L50 - Potenza assorbita L35L50 - Leistungsaufnahme L35L50 - Potencia absorbida L35L50 - DIN3168	W	1580	1660	1580
Side cabinet fan flow, free blowing - Portata aria ventil. lato armadio, bocca libera - Luftmenge Schrankseite, freiblasend - Caudal aire ventil. Lado armario	m <sup>3</sup> /h	860	860	860
Regulation Temperature limits - Limiti di regolazione Temperatura - Temperatur Einstellbereich - limites de ajuste de Temperatura	°C	25 - 45	25 - 45	25 - 45
Side ambient Temperature limits - Limiti di Temperatura lato ambiente - Umgebungstemperatur - Limites Temperatura lado ambiente	°C	20 - 55	20 - 55	20 - 55
Side cabinet protection degree - Protezione lato armadio - Schutzgrad Schrankseite - Protección lado armario	IP	54	54	54
Noise level - Rumorosità - Geräuschpegel - Nivel de ruido	dB(A)	77	77	77
Weight - Peso - Gewicht - Peso	kg	74,5	74,5	76,5

**OPTIONAL**

- Special Colour - Colore Speciale OCAHNS01
- Stainless Steel Housing - Carpenteria Inox AISI304 OCAHI28
- Air Filter - Filtro Aria ACAFIL28T





# TOP II ETE41

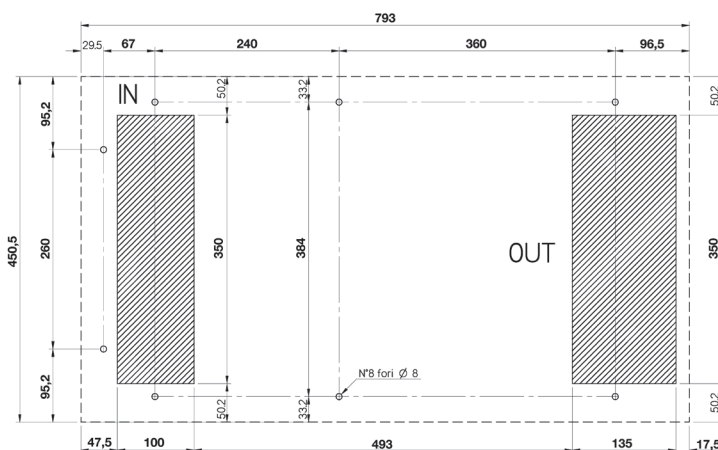
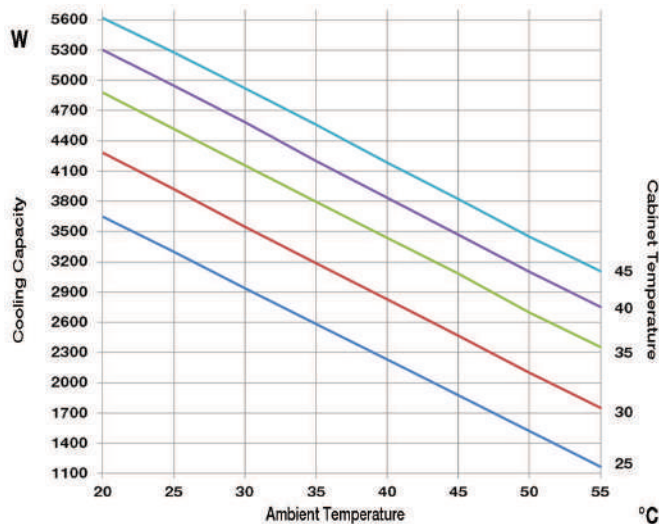
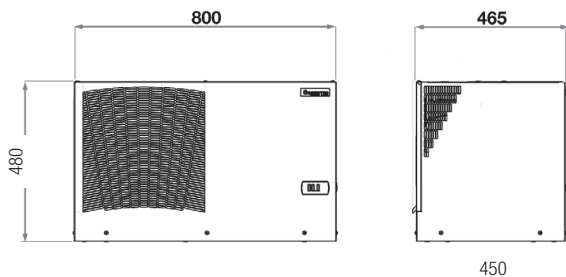

CODE - CODICE - MODEL - CODIGO	M.U.	ETE41002207000	ETE41U02207000	ETE41002617000	ETE41U02627200
Power supply - Alimentazione - Spannungsversorgung - Tensión	V - ph - Hz	230-1-50/60	230-1-60	400-3-50 460-3-60	400-3-50 460-3-60
Cooling capacity L35L35 - Potenza raffreddamento L35L35 Kälteleistung L35L35 - Potencia frigorífica L35L35 - DIN 3168	W	3800	3800	3800	3800
Cooling capacity L35L50 - Potenza raffreddamento L35L50 Kälteleistung L35L50 - Potencia frigorífica L35L50 - DIN 3168	W	2700	2700	2700	2700
Height / Widht / Depth - Altezza / Larghezza / Profondità Höhe / Breite / Tiefe - Altura / Ancho / Profundidad	mm	480x800x450	480x800x450	480x800x450	480x800x450
Max running current - corrente max, in marcia Max. Stromaufnahme - Corriente máxima, en marcha	A	9	9	2,9	3,5
Starting current - Corrente assorbita alla partenza Anlaufstrom - Corriente absorbida al arranque	A	38	38	17	7
Pre-Fuse T - Fusibile T - Absicherung T - Elemento previo de fusibile T	A	16	16	8	8
Power consumption L35L50 - Potenza assorbita L35L50 Leistungsaufnahme L35L50 - Potencia absorbida L35L50 - DIN3168	W	2000	2050	2000	1550
Side cabinet fan flow, free blowing - Portata aria ventil. lato armadio, bocca libera Luftmenge Schrankseite, freiblasend - Caudal aire ventil. Lado armario	m <sup>3</sup> /h	1450	1450	1450	1450
Regulation Temperature limits - Limiti di regolazione Temperatura Temperatur Einstellbereich - limites de ajuste de Temperatura	°C	25 - 45	25 - 45	25 - 45	25 - 45
Side ambient Temperature limits - Limiti di Temperatura lato ambiente Umgebungstemperatur - Limites Temperatura lado ambiente	°C	20 - 55	20 - 55	20 - 55	20 - 55
Side cabinet protection degree - Protezione lato armadio Schutzgrad Schrankseite - Protección lado armario	IP	54	54	54	54
Noise level - Rumorosità - Geräuschpegel - Nivel de ruido	dB(A)	77	77	77	77
Weight - Peso - Gewicht - Peso	kg	76,5	76,5	79,5	76,5

### OPTIONAL

Special Colour - Colore Speciale	OCAHNS01
Stainless Steel Housing - Carpentaria Inox AISI304	OCAHI28
Air Filter - Filtro Aria	ACAFILT28T







# TOP II ETE60

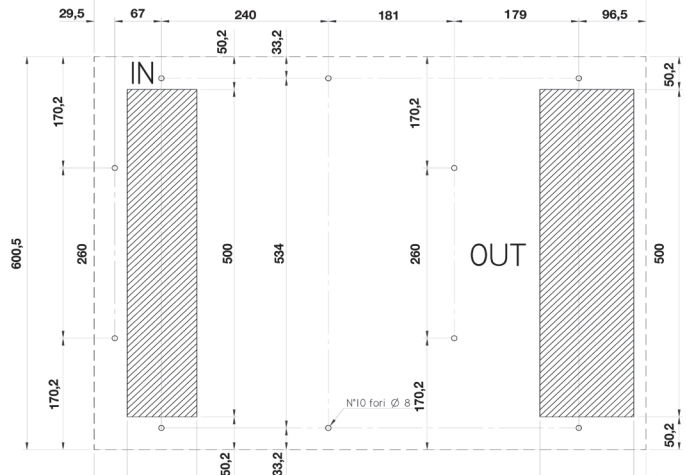
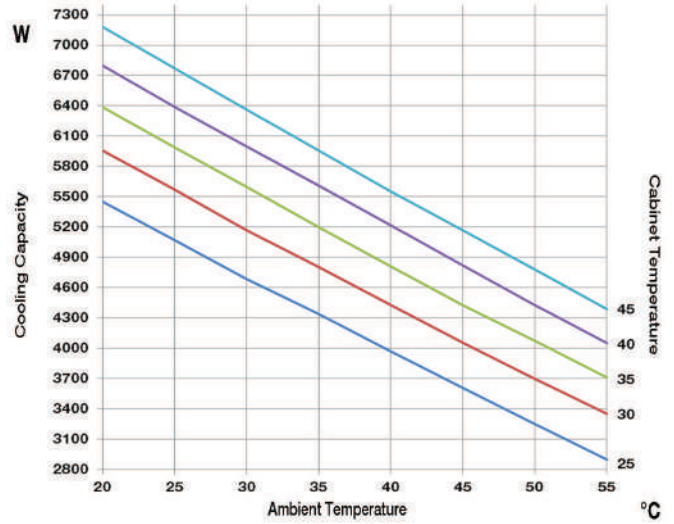
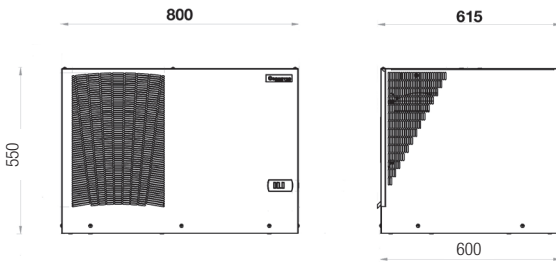

CODE - CODICE - MODEL - CODIGO	M.U.	ETE60002617000
Power supply - Alimentazione - Spannungsversorgung - Tensiòn	V - ph - Hz	400-3-50 460-3-60
Cooling capacity L35L35 - Potenza raffreddamento L35L35 Kälteleistung L35L35 - Potencia frigorífica L35L35 - DIN 3168	W	5200
Cooling capacity L35L50 - Potenza raffreddamento L35L50 Kälteleistung L35L50 - Potencia frigorífica L35L50 - DIN 3168	W	4100
Height / Widht / Depth - Altezza / Larghezza / Profondità Höhe / Breite / Tiefe - Altura / Ancho / Profundidad	mm	550x800x600
Max running current - corrente max, in marcia Max. Stromaufnahme - Corriente máxima, en marcha	A	4,6
Starting current - Corrente assorbita alla partenza Anlaufstrom - Corriente absorbida al arranque	A	25
Pre-Fuse T - Fusibile T - Absicherung T - Elemento previo de fusibile T	A	10
Power consumption L35L50 - Potenza assorbita L35L50 Leistungsaufnahme L35L50 - Potencia absorbida L35L50 - DIN3168	W	2540
Side cabinet fan flow, free blowing - Portata aria ventil. lato armadio, bocca libera Luftmenge Schrankseite, freiblasend - Caudal aire ventil. Lado armario	m3/h	1720
Regulation Temperature limits - Limiti di regolazione Temperatura Temperatur Einstellbereich - limites de ajuste de Temperatura	°C	25 - 45
Side ambient Temperature limits - Limiti di Temperatura lato ambiente Umgebungstemperatur - Limites Temperatura lado ambiente	°C	20 - 55
Side cabinet protection degree - Protezione lato armadio Schutzgrad Schrankseite - Proteccion lado armario	IP	54
Noise level - Rumorosità - Geräuschpegel - Nivel de ruido	dB(A)	77
Weight - Peso - Gewicht - Peso	kg	94

**OPTIONAL**

- Special Colour - Colore Speciale OCAHNS01
- Stainless Steel Housing - Carpenteria Inox AISI304 OCAH160
- Air filter - Filtro Aria ACAFILT60T